

Audio System <13 Speaker> , Navigation System , Parking Assist <Rear View Monitor w/ Navigation System>

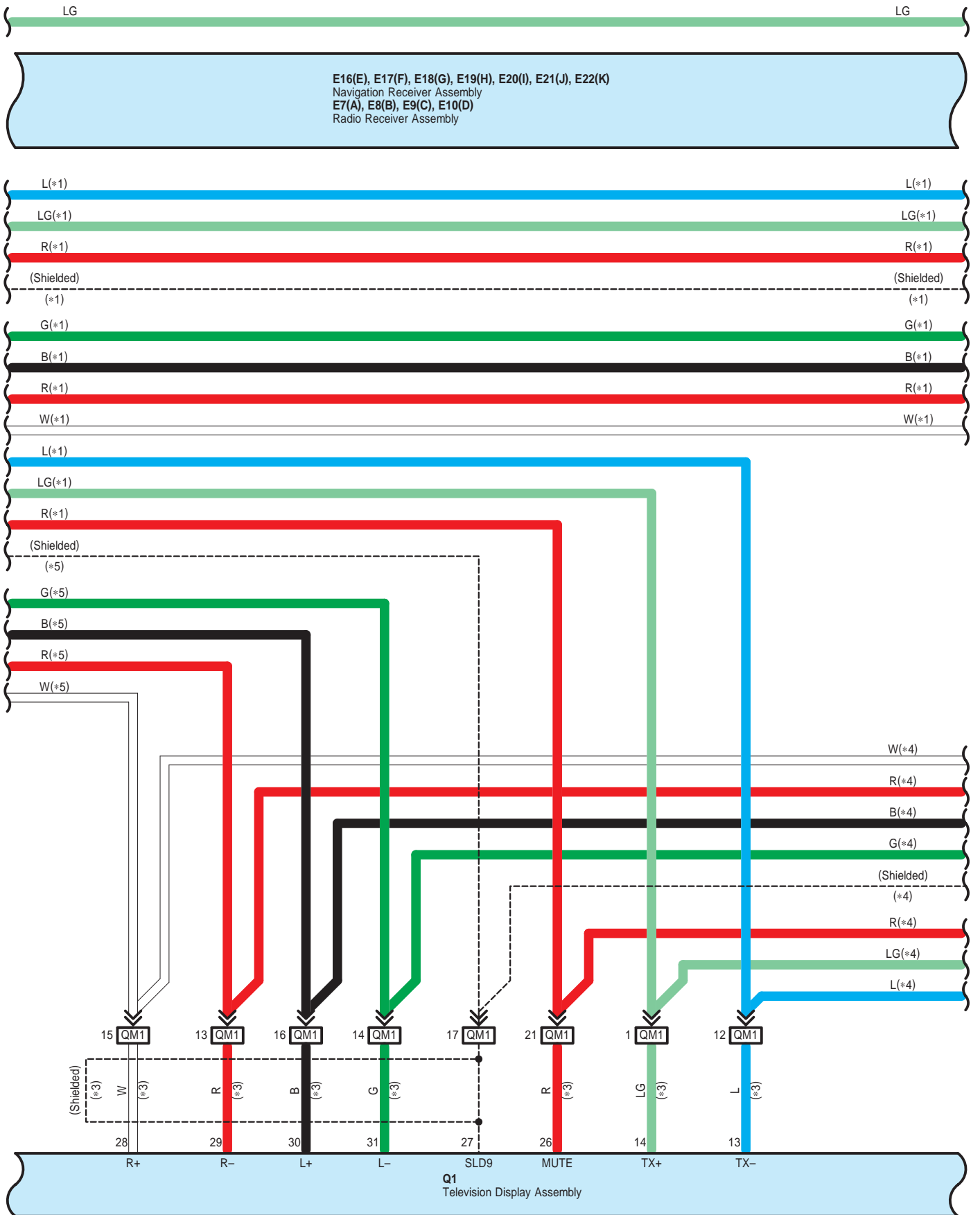

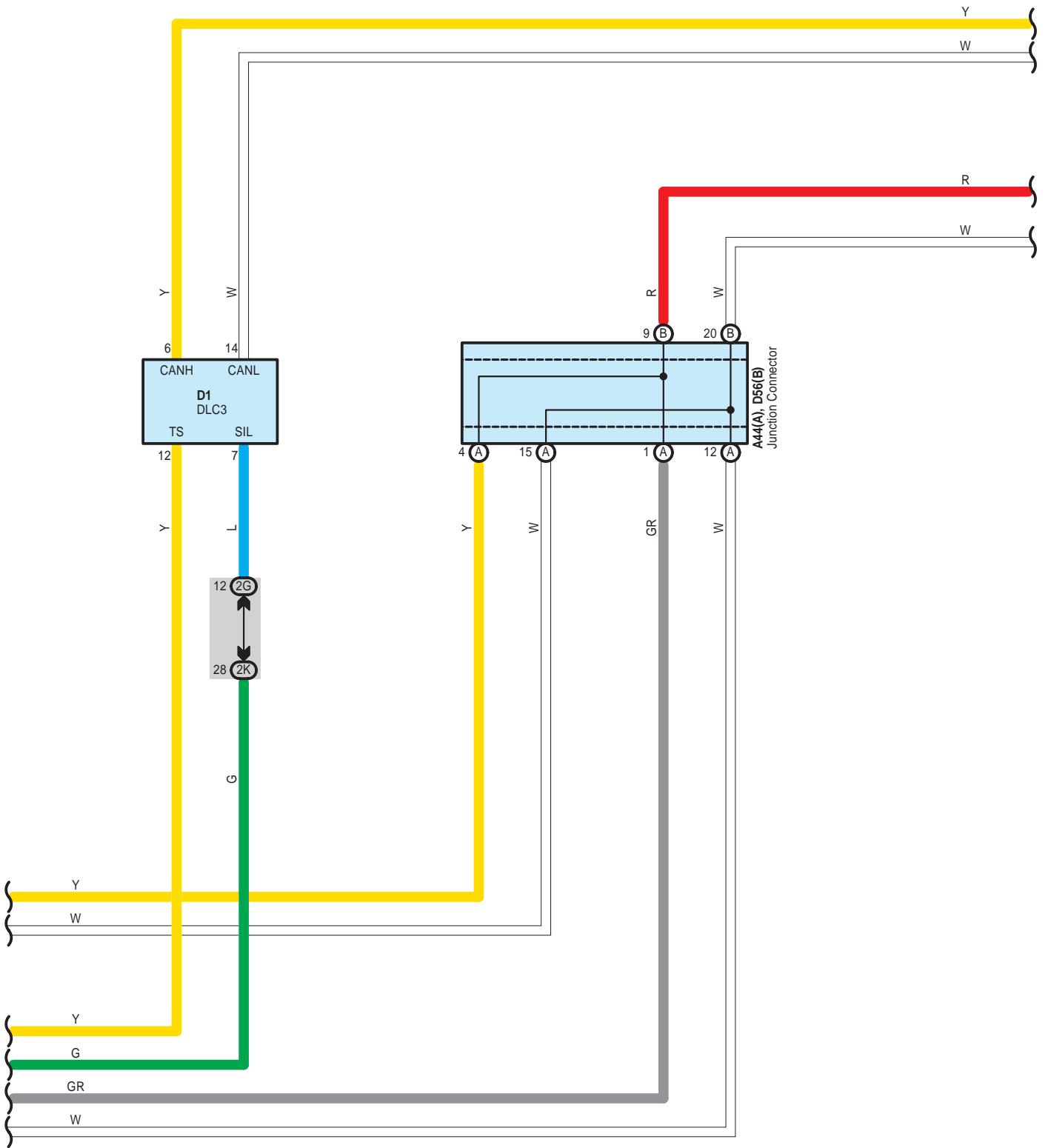

2K
White

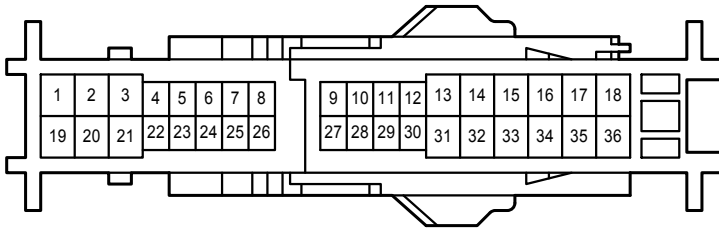

BA2
White

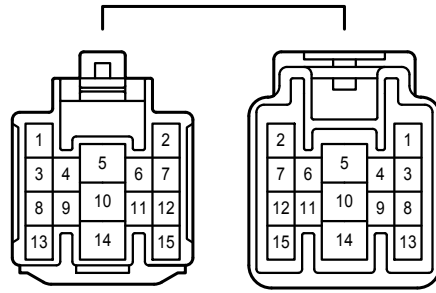

DA1
Gray

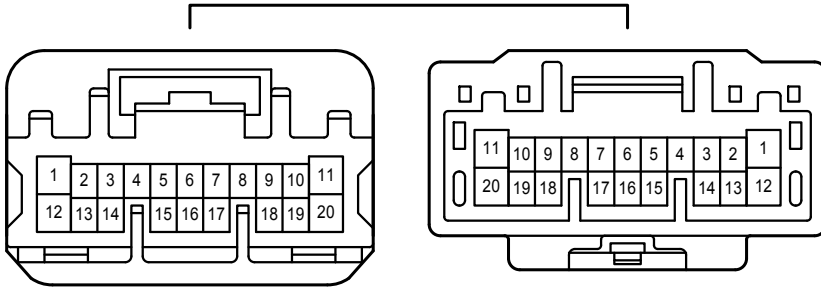

DA2
Black

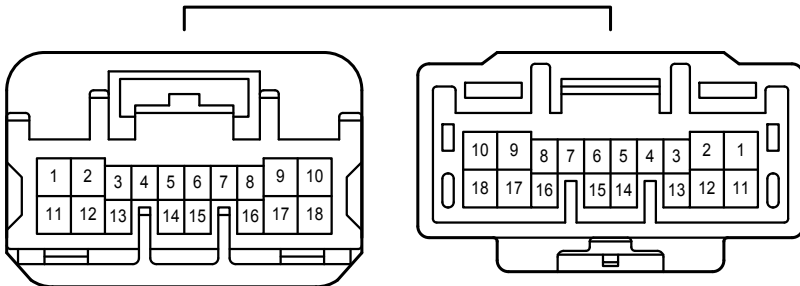

DA5
White

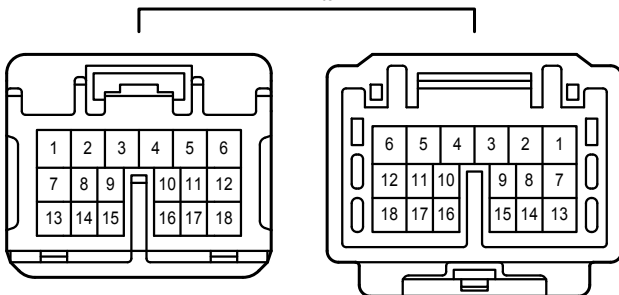

DE1
White

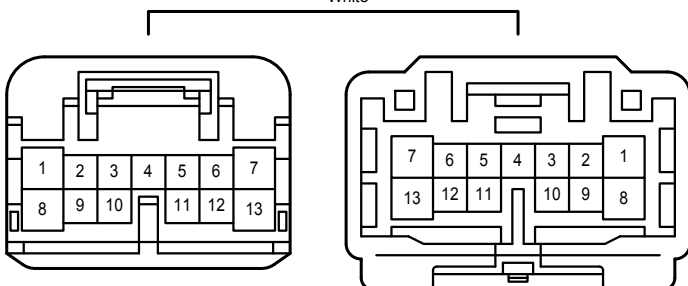

A 42
Black

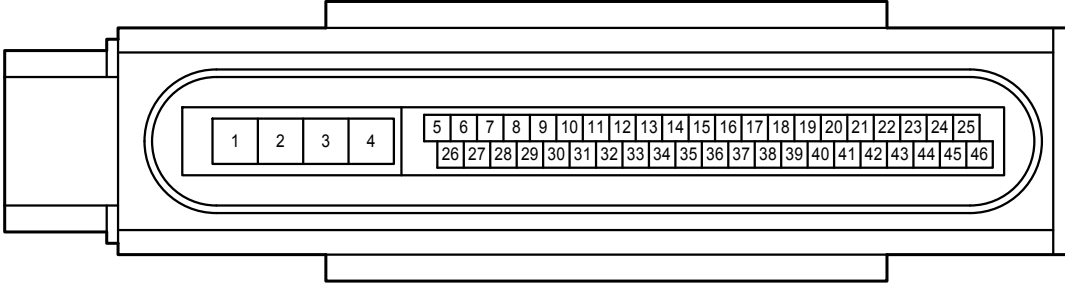

B 2
Gray

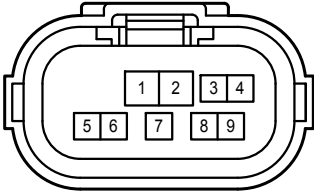

D 18
Black

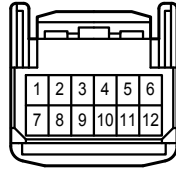

D 57
White

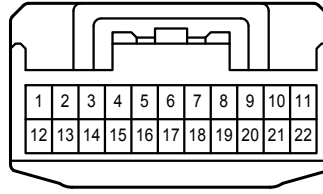

E 1
White

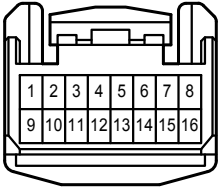

E 2
White

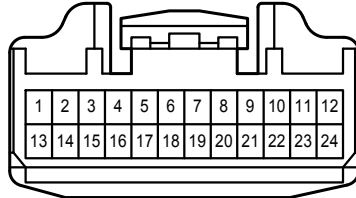

E 7
White

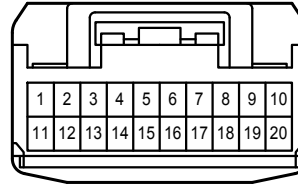

E 8
White

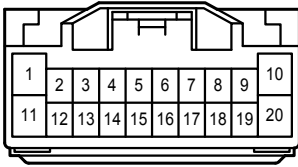

E 9
White

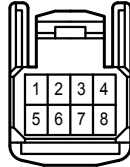

E 10
Gray

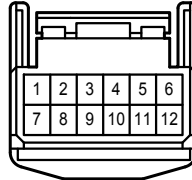

E 12
White

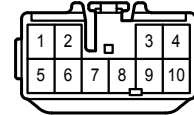

E 13
White

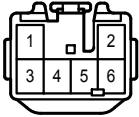

E 14
White

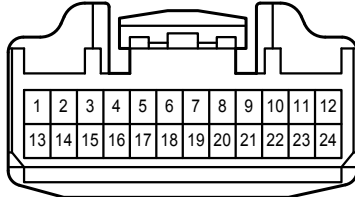

E 15
White

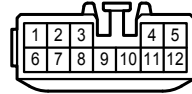

E 16
Gray

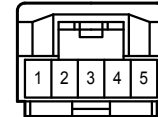

E 17
White

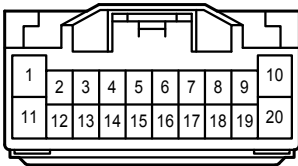

E 18
Black

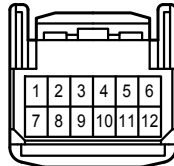

E 19
White

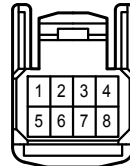

E 20
White

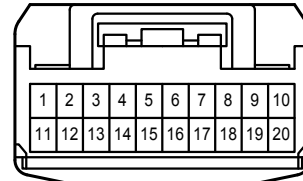

Automatic Glare-Resistant EC Mirror with Compass

D 58
White

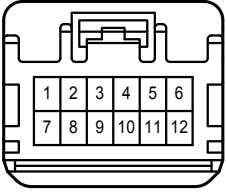

D 64
White

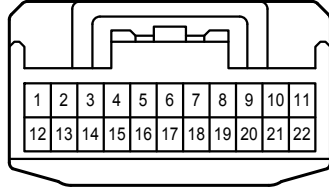

P 11
White

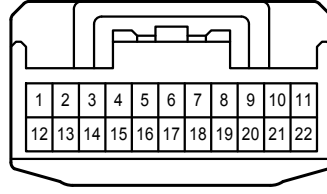

P 12
Black

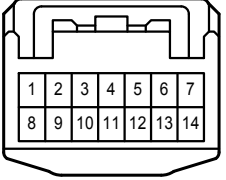

2R
White

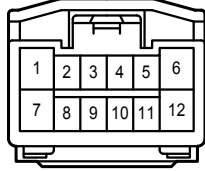

DP1
White

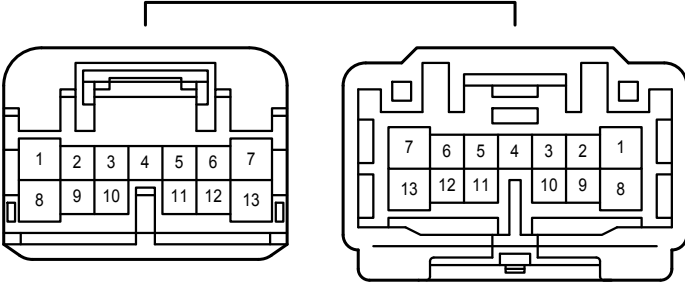

Back Door Opener <w/ Power Back Door> , Power Back Door

D48(C), D49(A), D51(D)
Main Body ECU

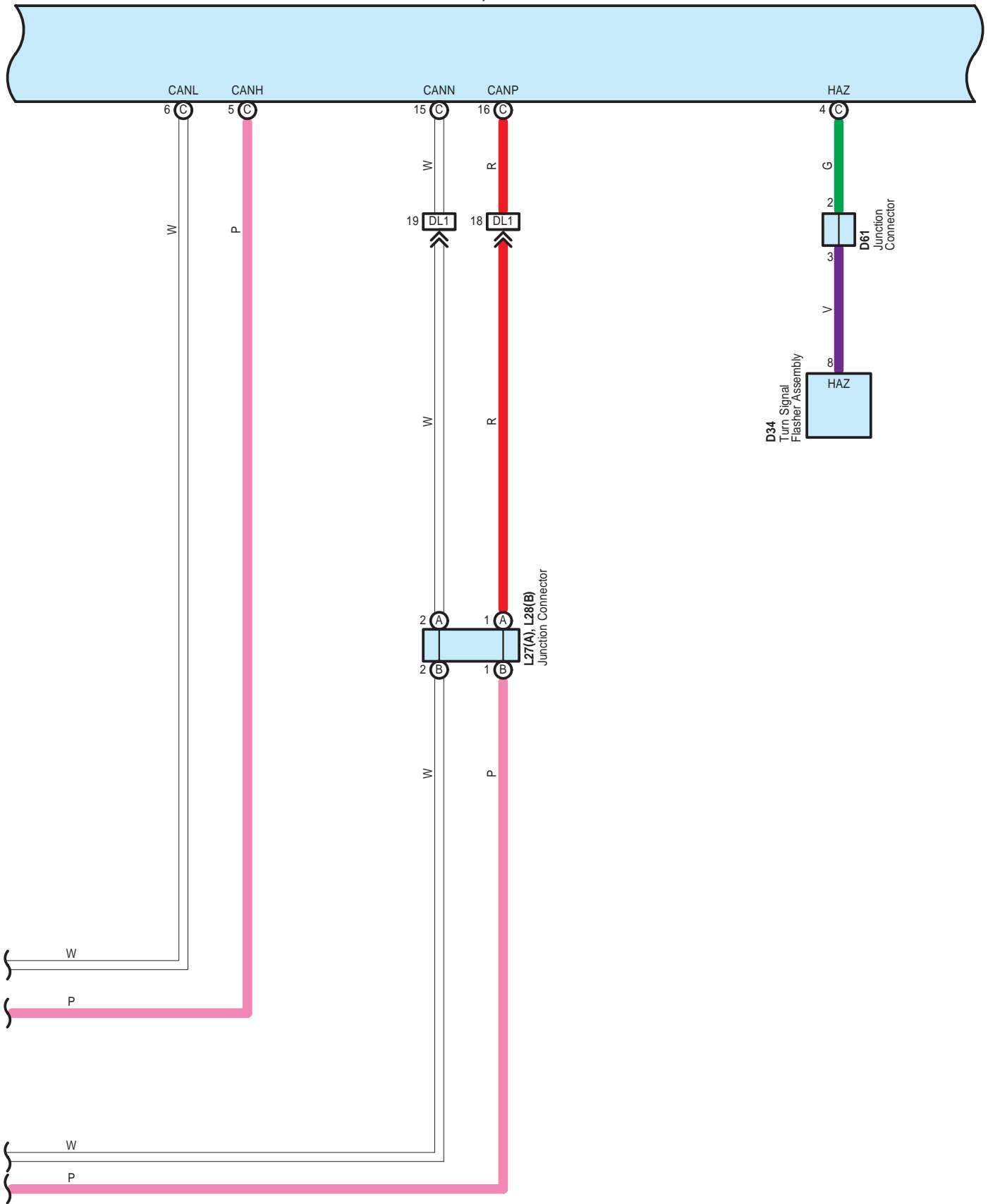

Charging

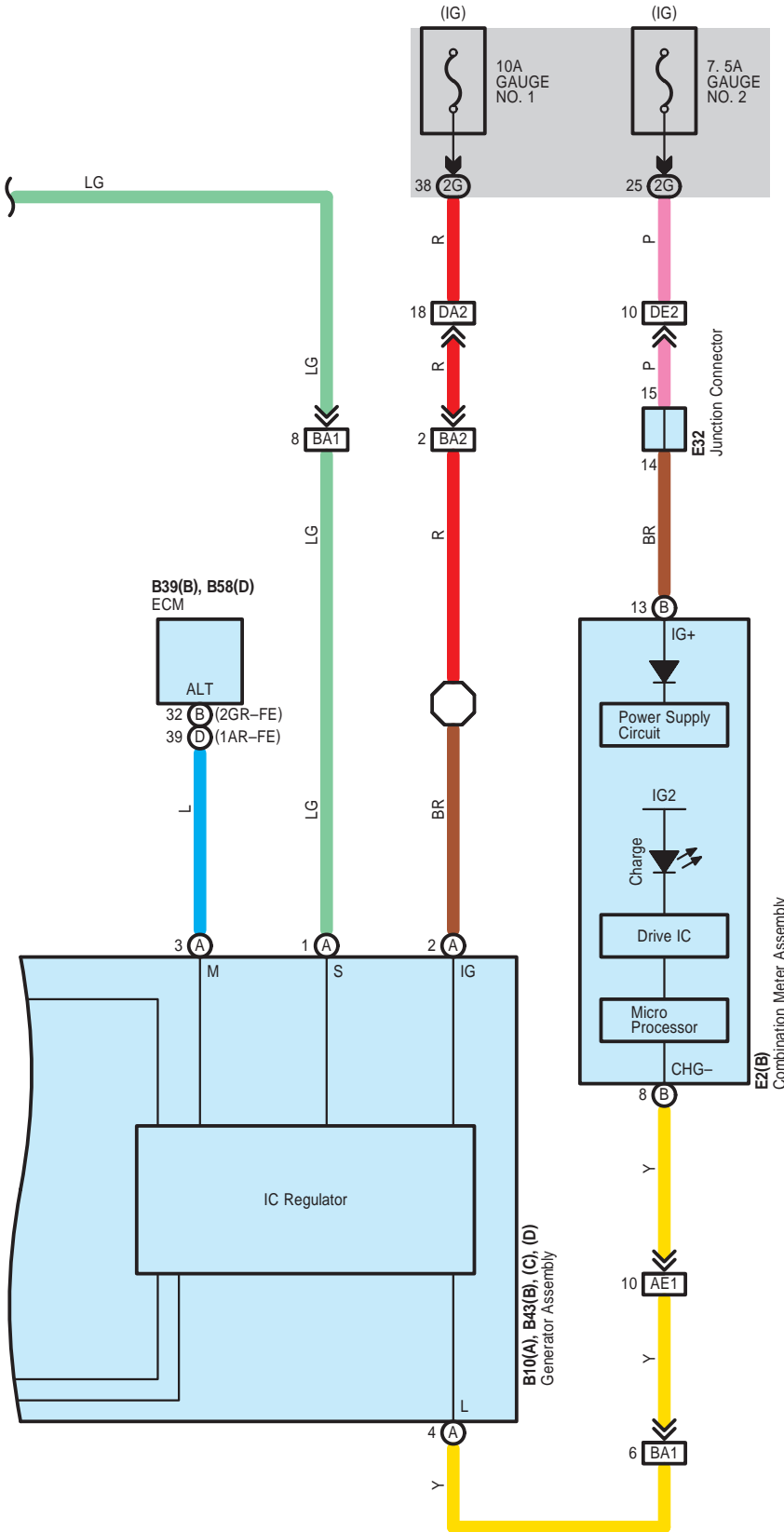

* 1 : Except 100A Type Generator Assembly
 * 2 : 100A Type Generator Assembly

Combination Meter , Multi Display , Parking Assist <Rear View Monitor w/o Navigation System>

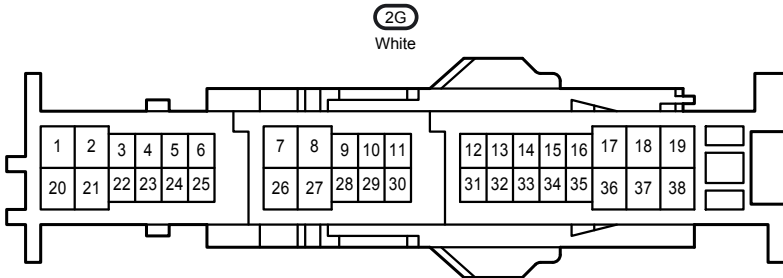
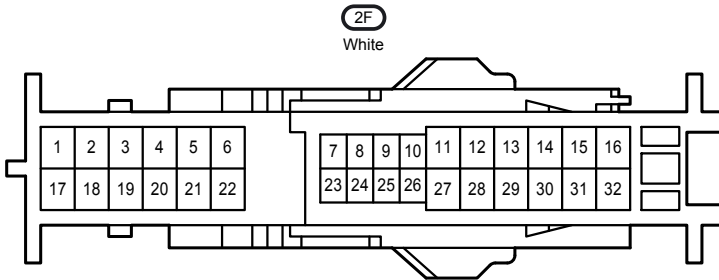
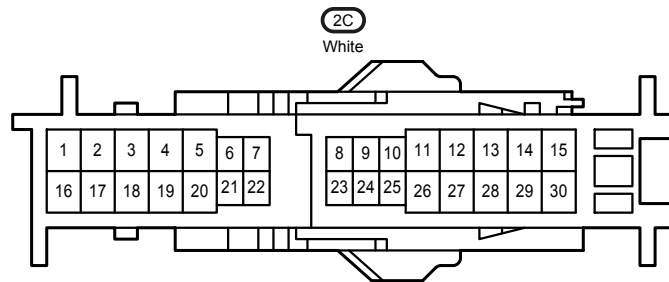
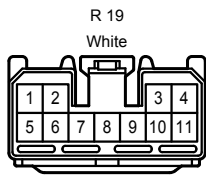
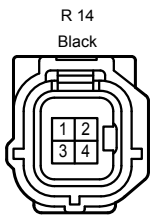
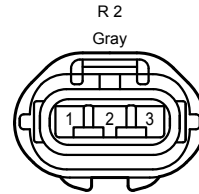
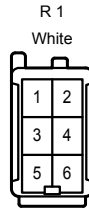
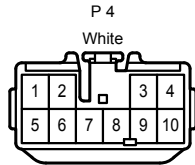
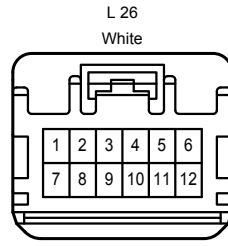
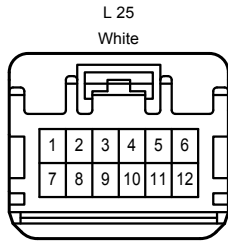
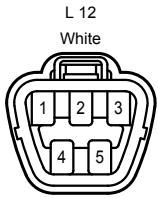

DE1
White

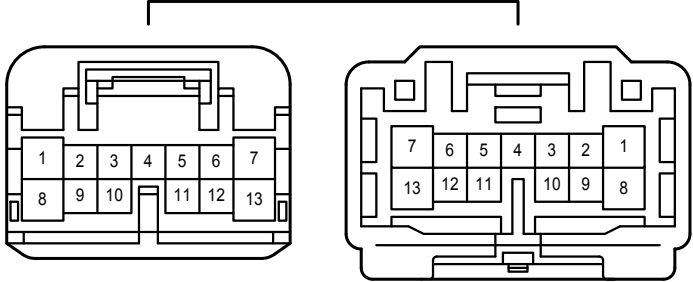

DE2
White

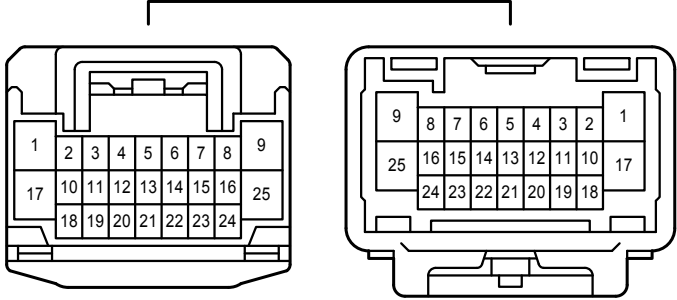

EF1
White

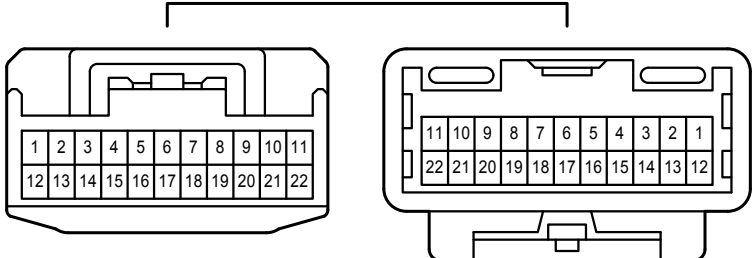

EF2
White

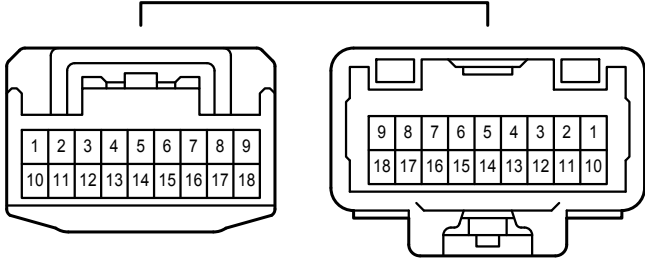

HD1
White

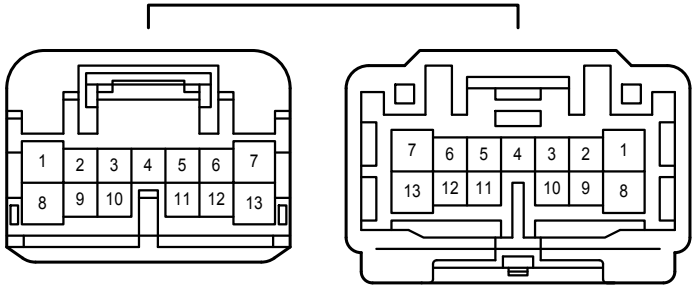

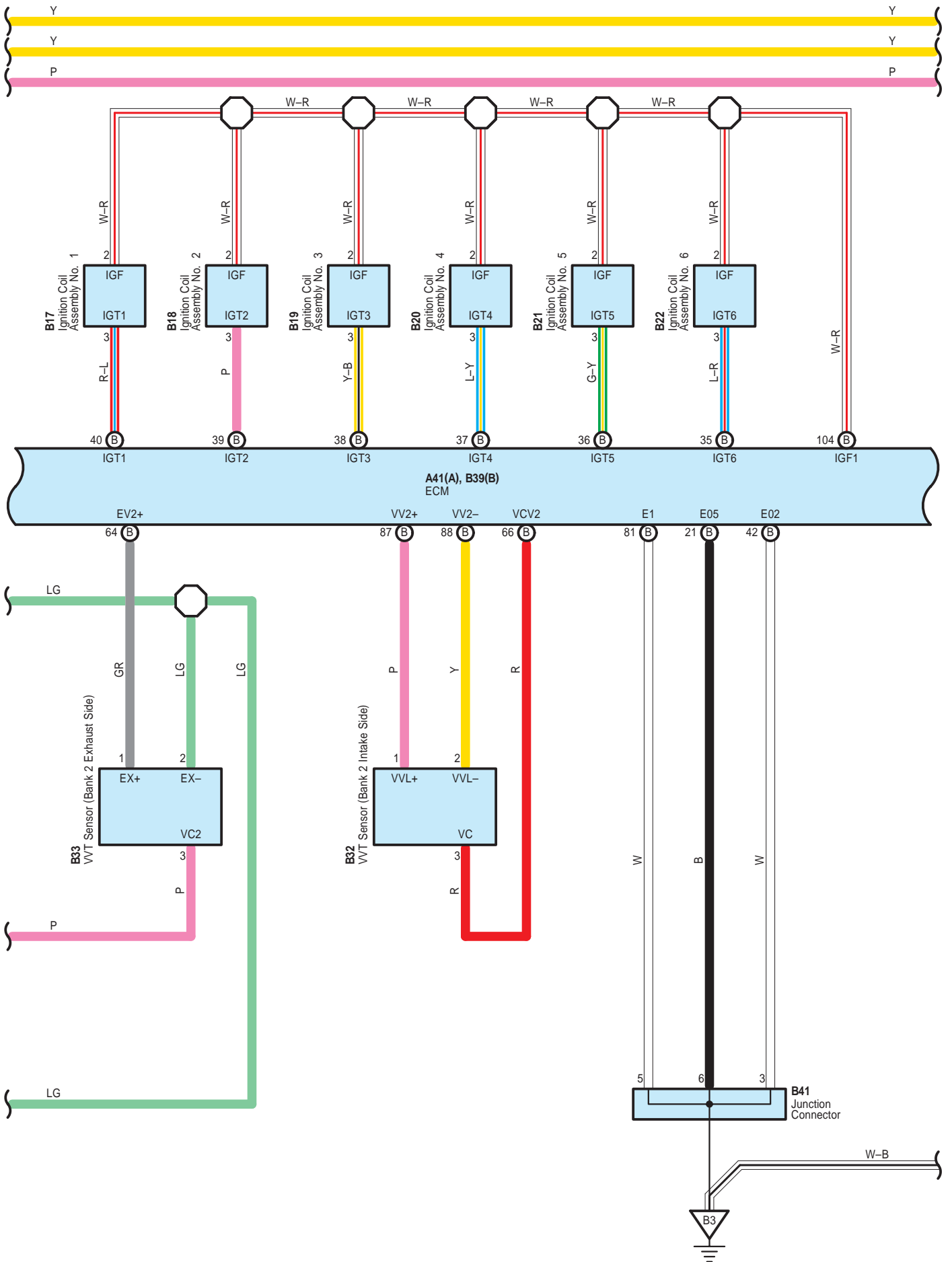

2G

White

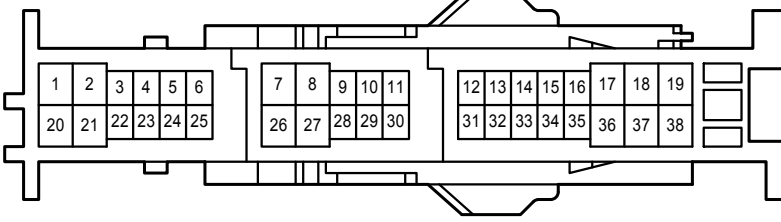

2K

White

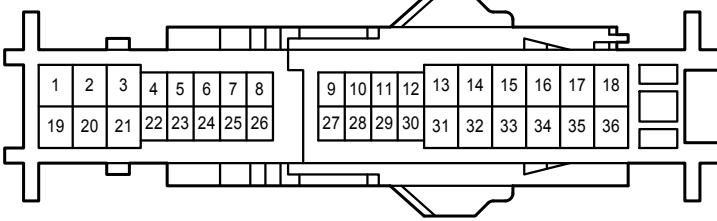

AE1

White

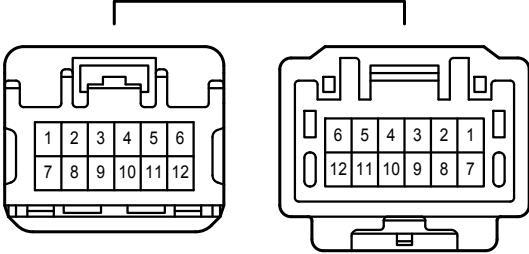

BA1

White

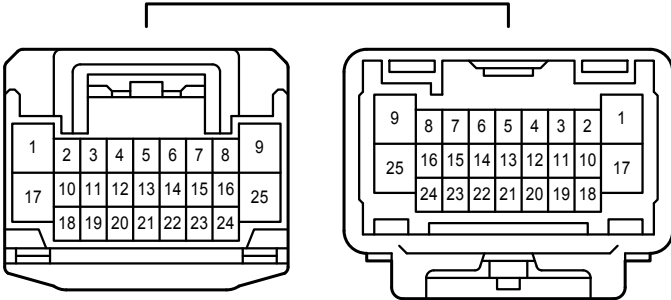

BA2

White

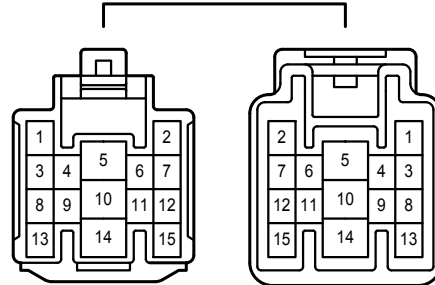

BU1

Gray

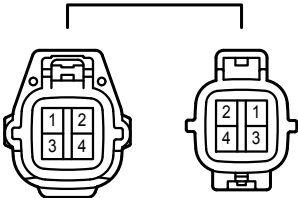

DA1

Gray

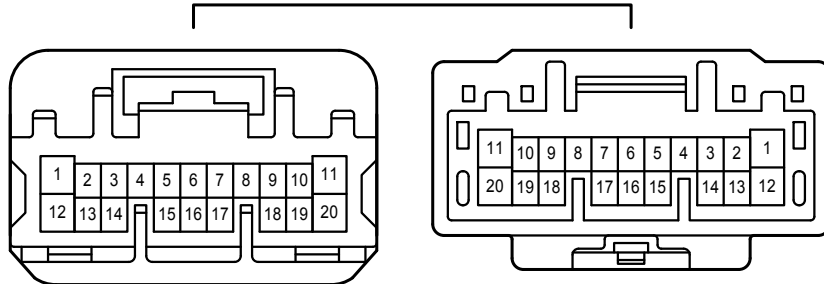

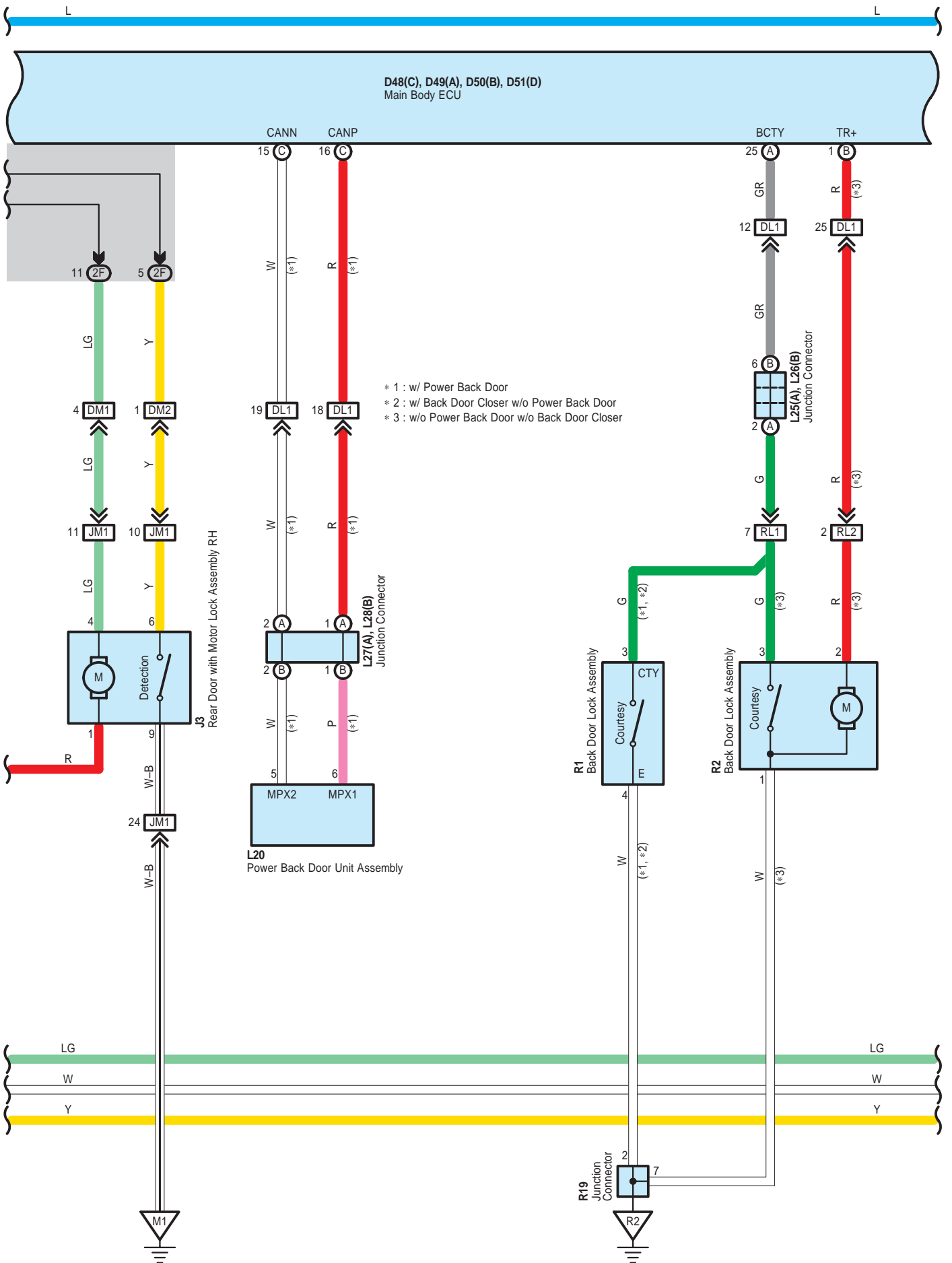

Engine Immobiliser System <w/o Smart Key System>

* 1 : 2GR-FE
 * 2 : 1AR-FE

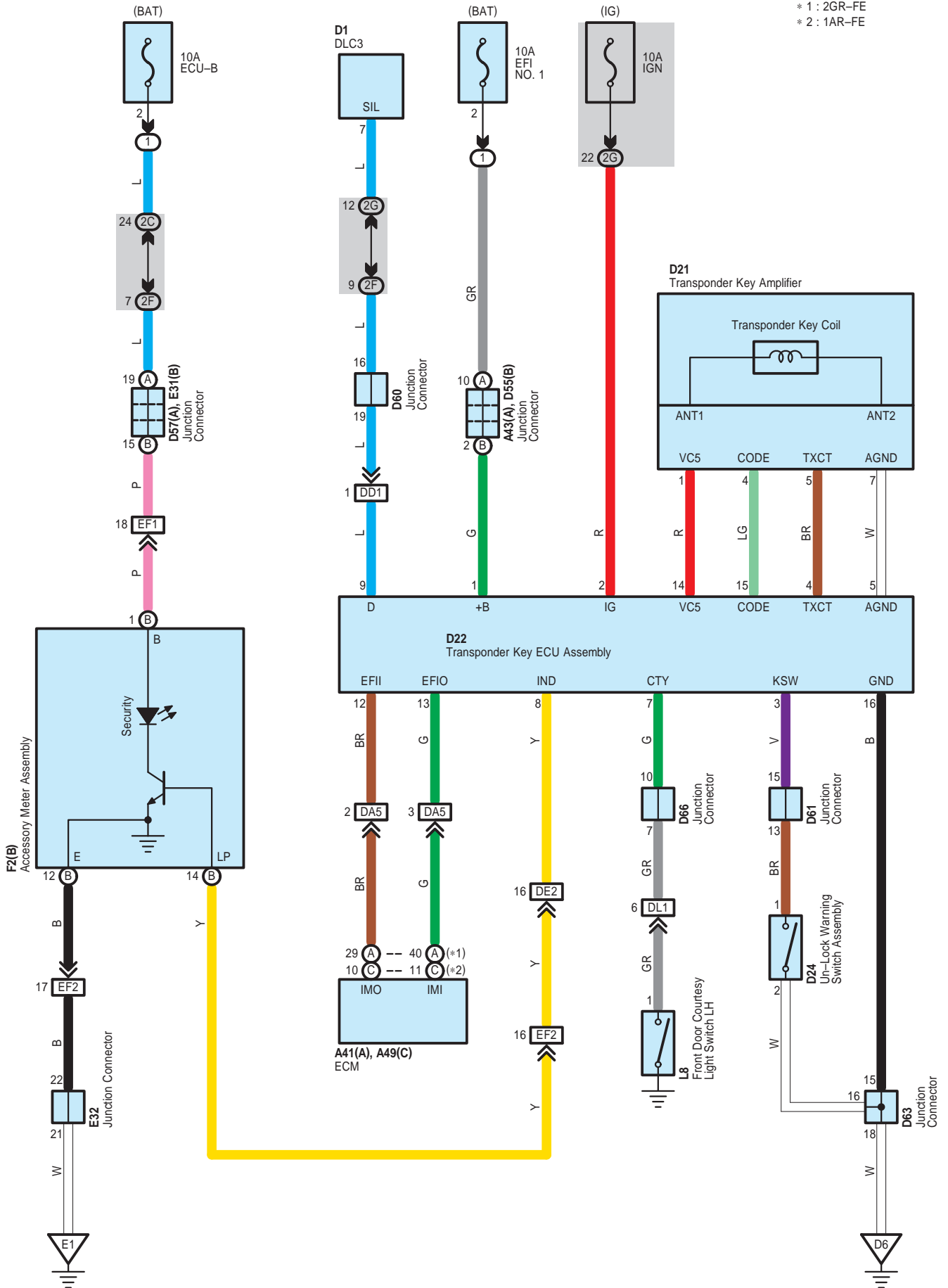

Headlight Beam Level Control

