

ABS, TRC, VSC

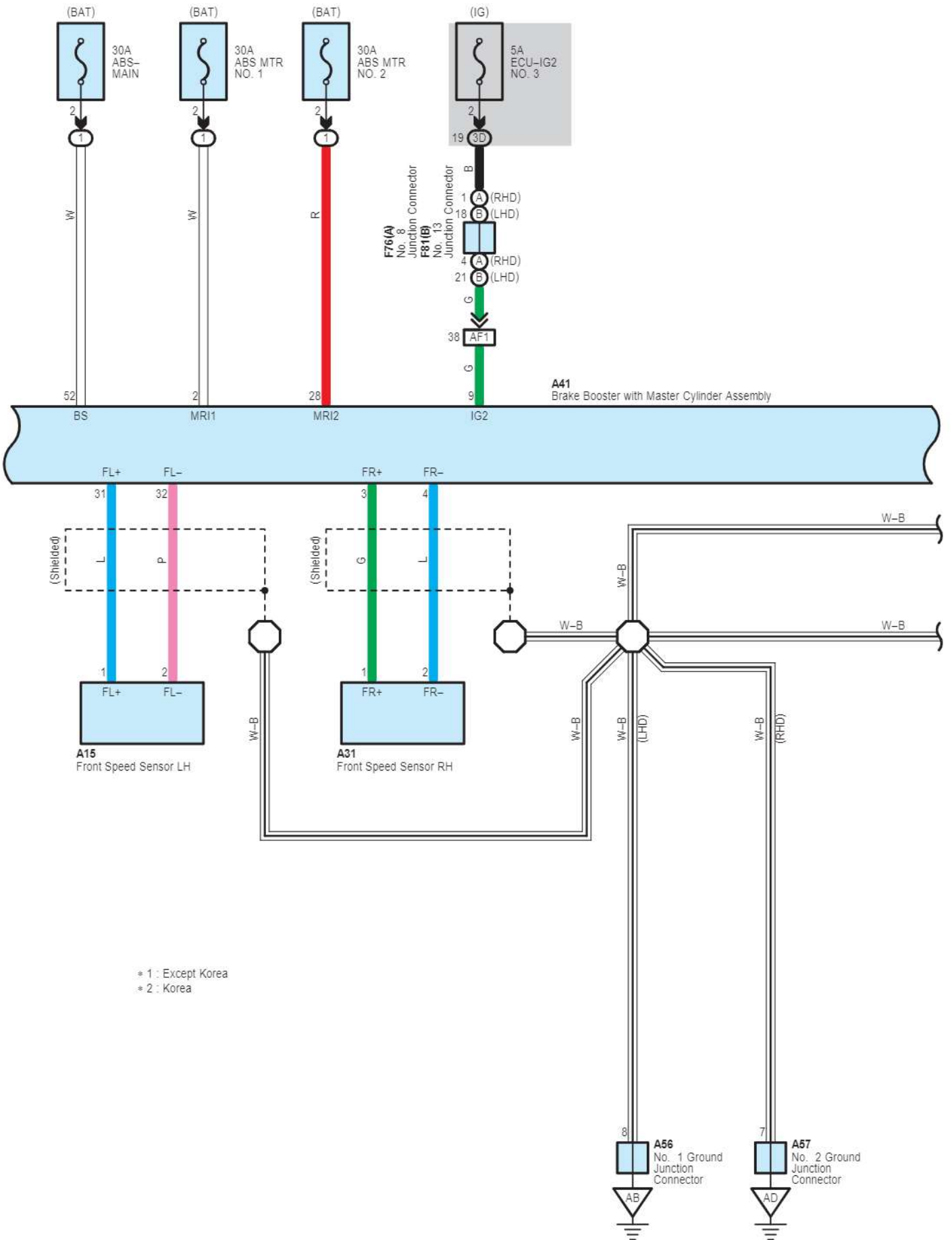

**A41**  
Brake Booster with Master Cylinder Assembly

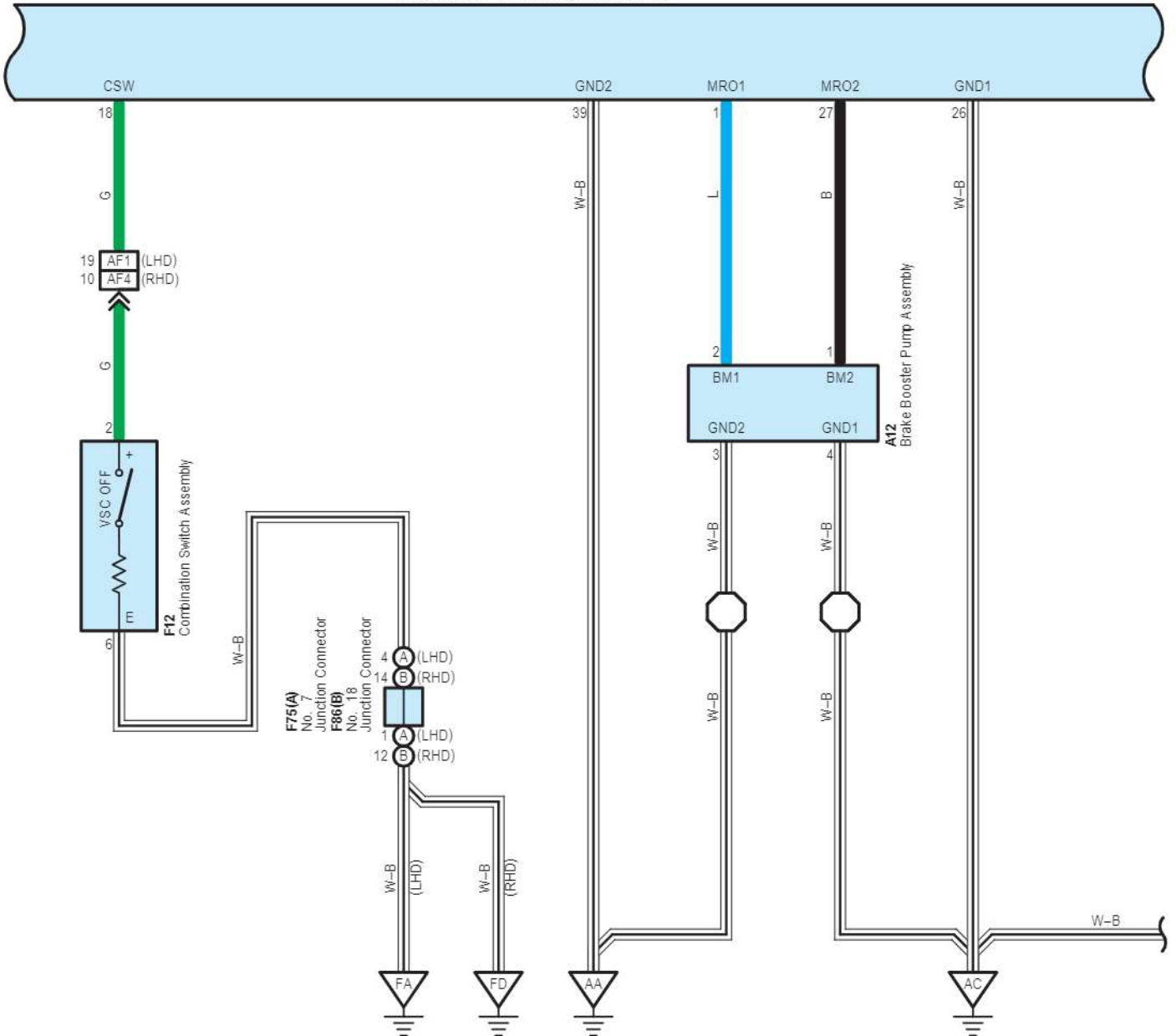

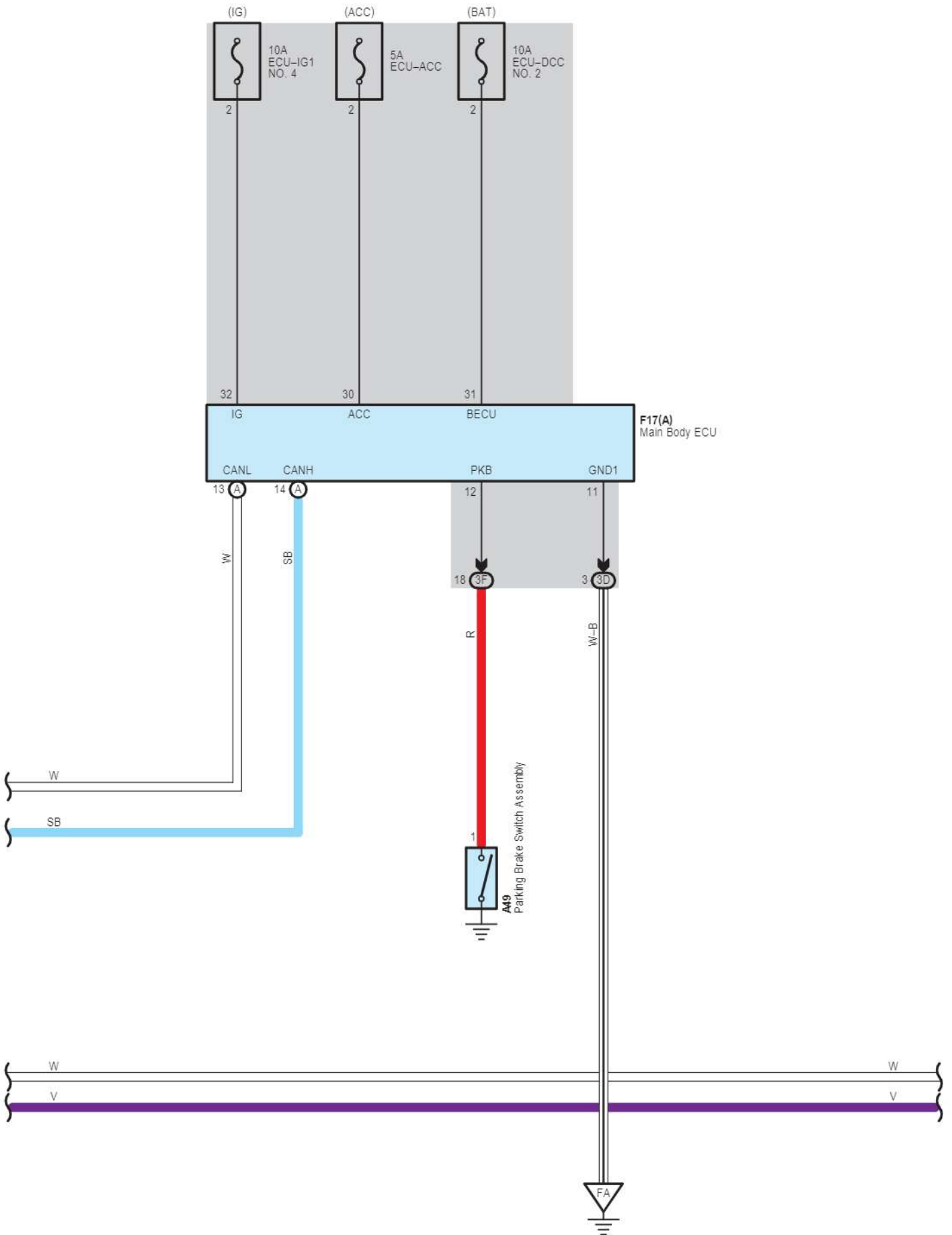

F74  
White

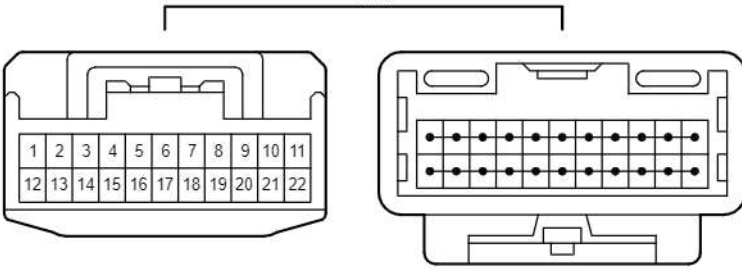

90980-12372  
(LHD)

F75  
Gray

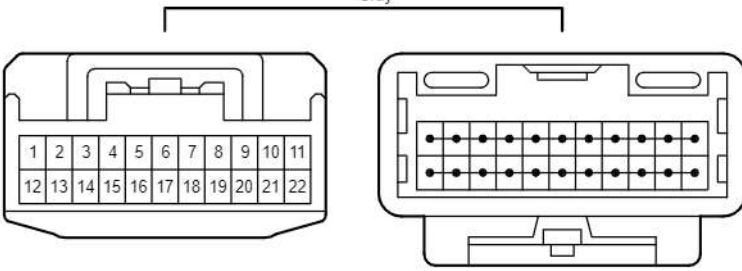

90980-12372

F76  
Gray

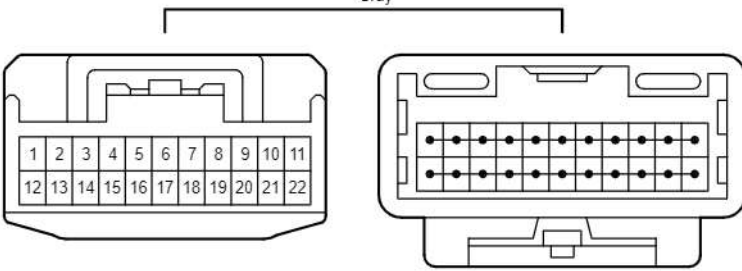

90980-12372

F77  
Blue

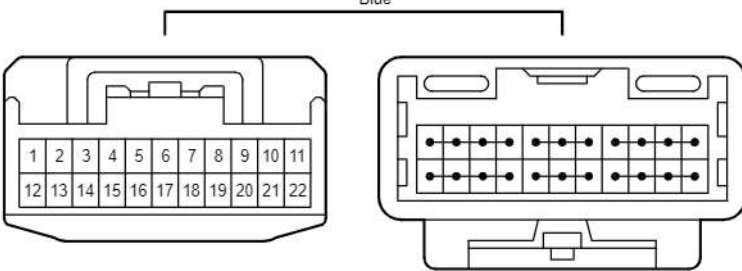

90980-12372

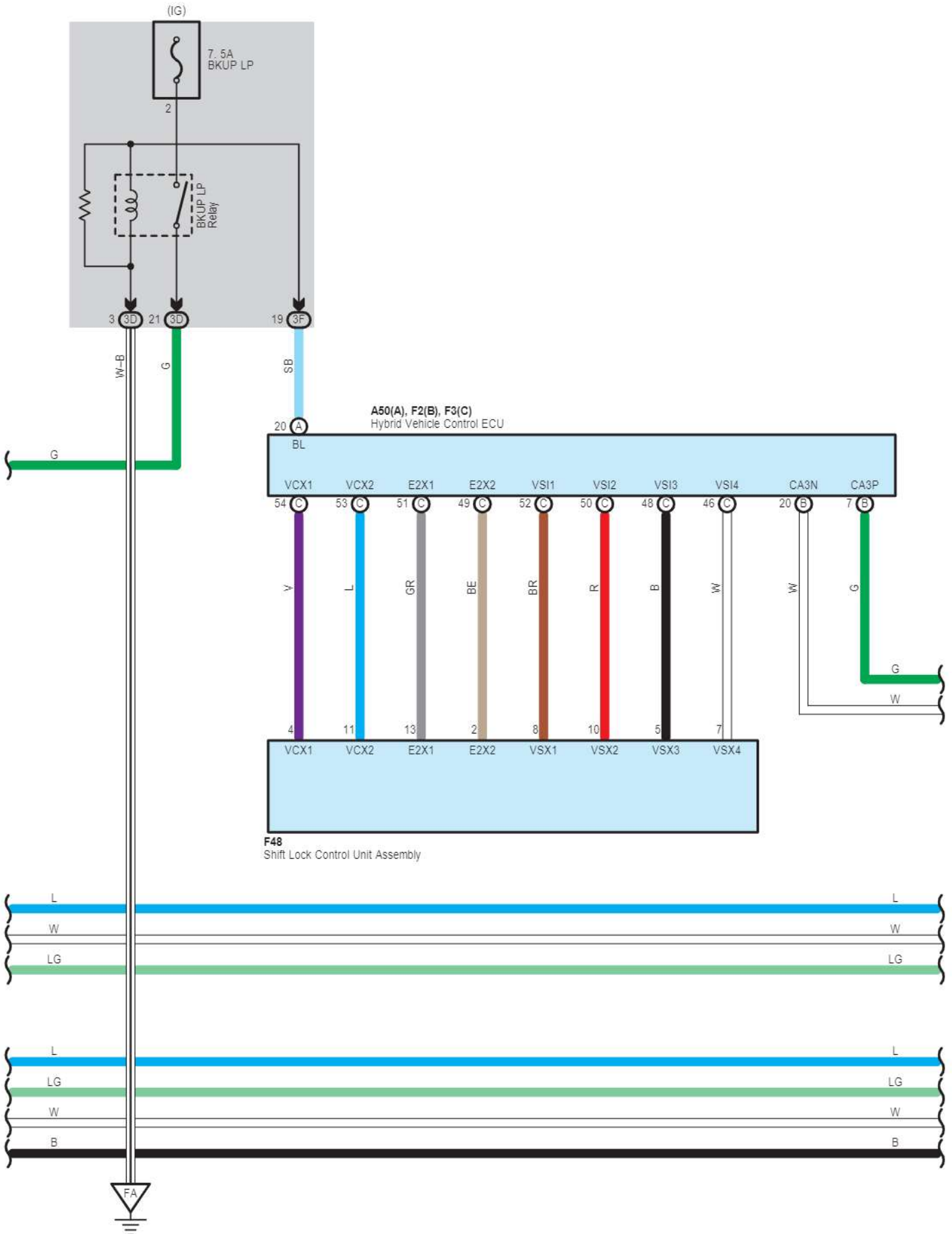

Combination Meter

- \* 3 : w/ Stereo Component Amplifier
- \* 4 : w/ Telematics System
- \* 5 : Except Korea
- \* 8 : w/ Rear Seat Belt Warning
- \* 9 : w/ Navigation System
- \*10 : w/o Navigation System

F6(A), F7(B)  
Combination Meter Assembly

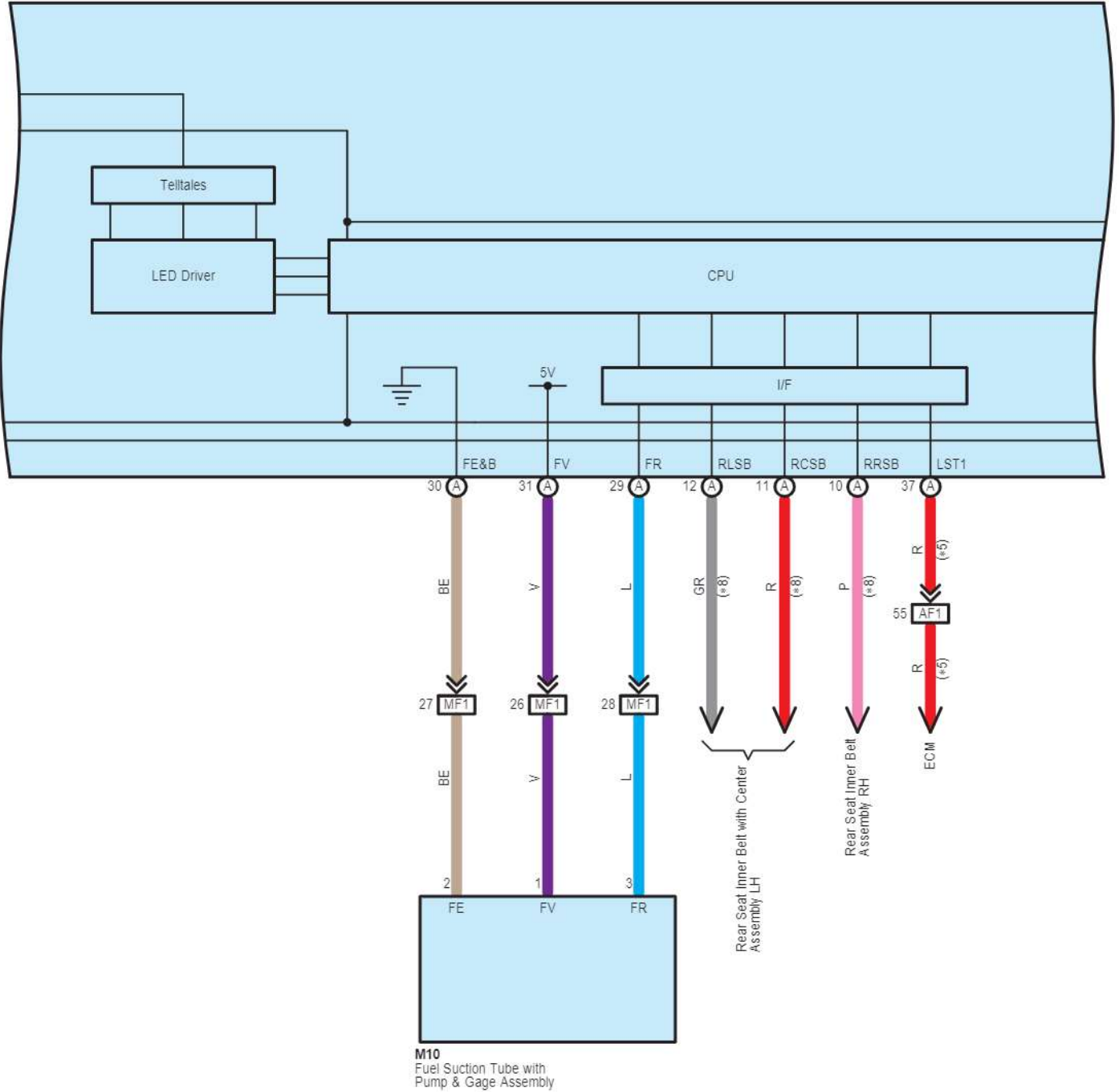

Door Lock Control (LHD)

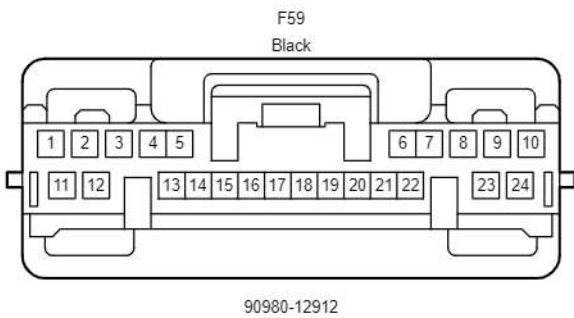
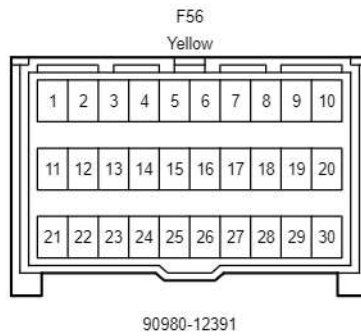
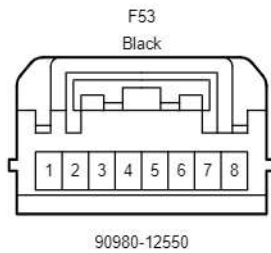
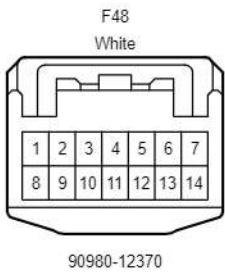
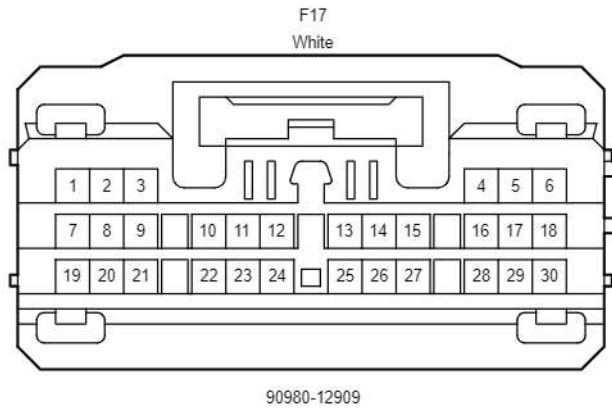
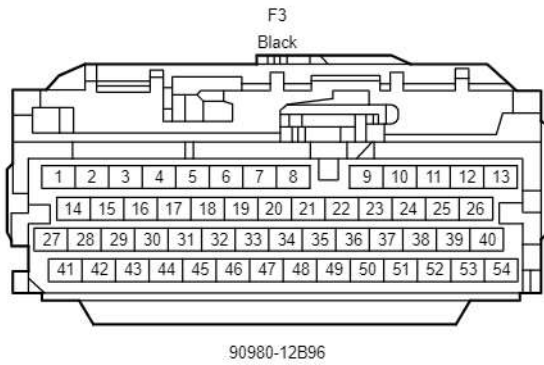
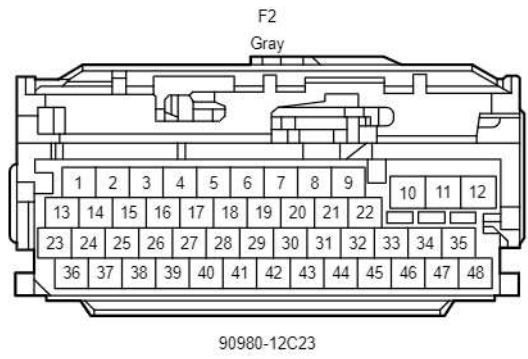
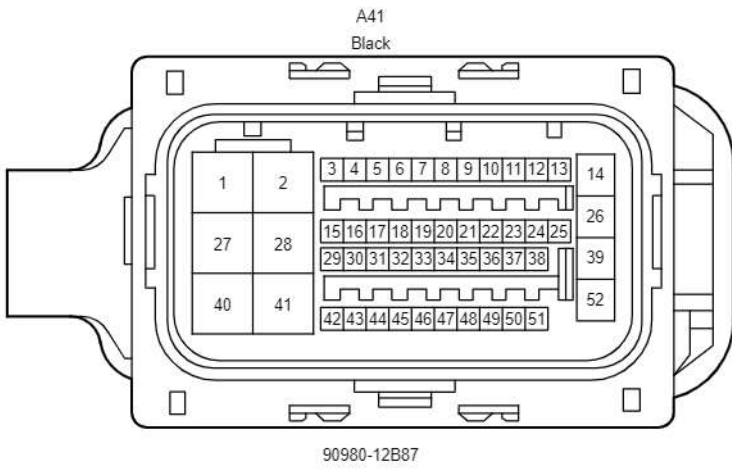

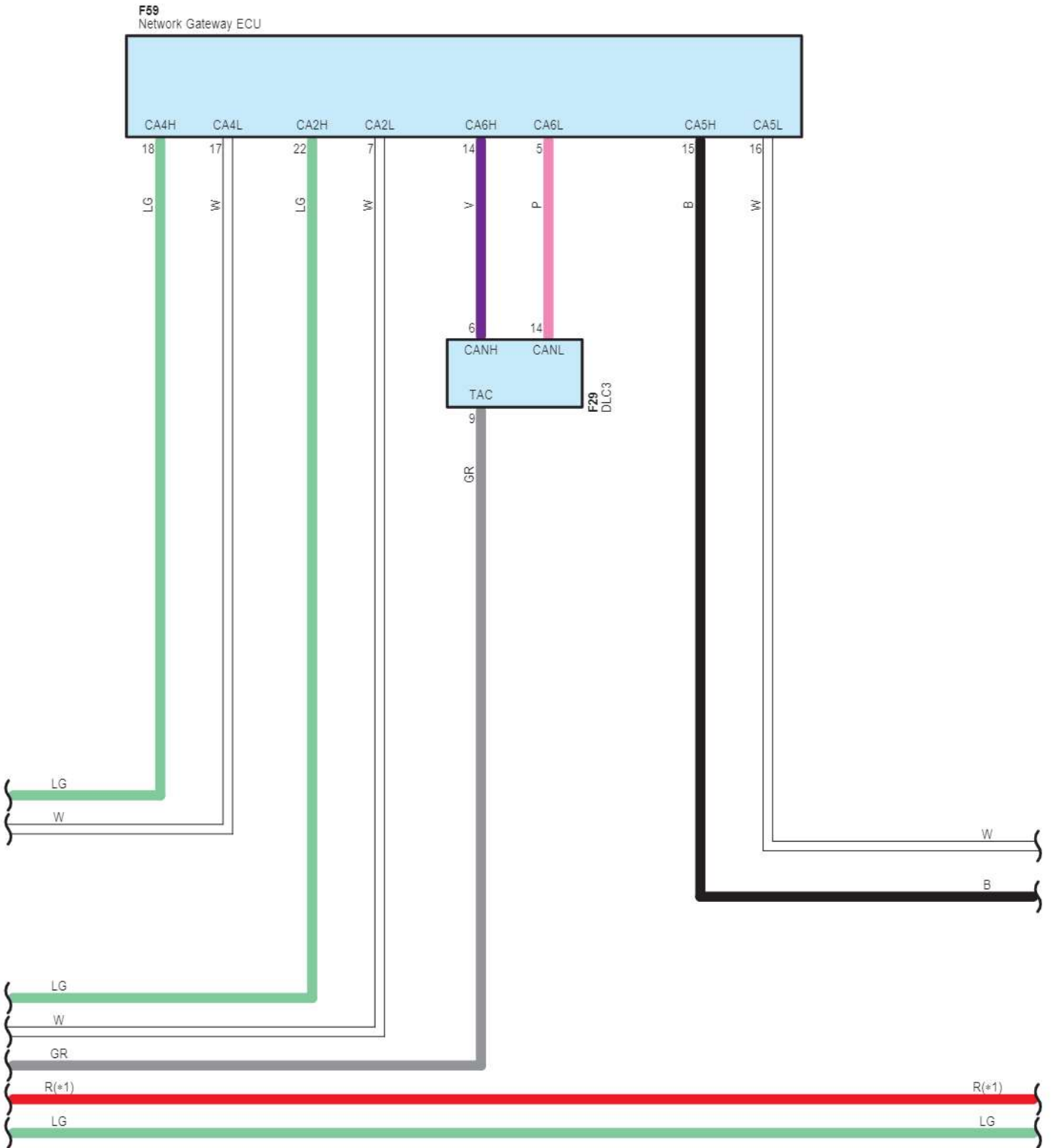

Front Wiper and Washer (w/ Auto Wiper System)

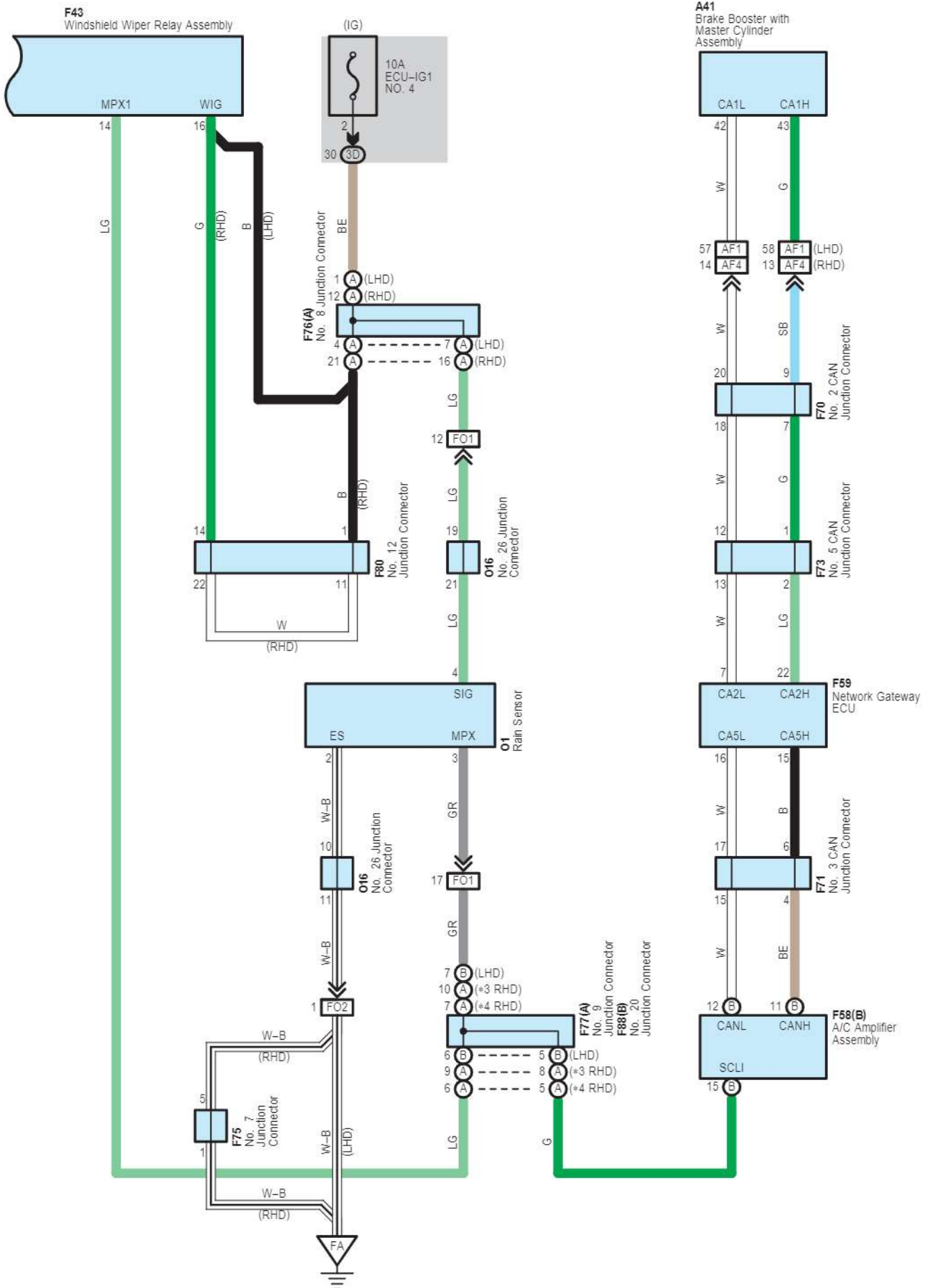

Ground Point (RHD)

- \* 5 : w/ Automatic High Beam
- \* 6 : Light Control Switch LH Side Type
- \* 7 : Light Control Switch RH Side Type
- \* 9 : w/ Sliding Roof
- \* 10 : w/o Sliding Roof
- \* 18 : w/ Seat Heater
- \* 19 : w/ Wireless Charger System
- \* 20 : w/ Navigation System
- \* 21 : w/o Navigation System
- \* 27 : Front Wiper and Washer (w/ Auto Wiper System)
- \* 32 : Built-in Type Amplifier
- \* 34 : w/o Audio System
- \* 36 : w/ Headup Display
- \* 37 : Before Nov. 2017 Production
- \* 38 : From Nov. 2017 Production

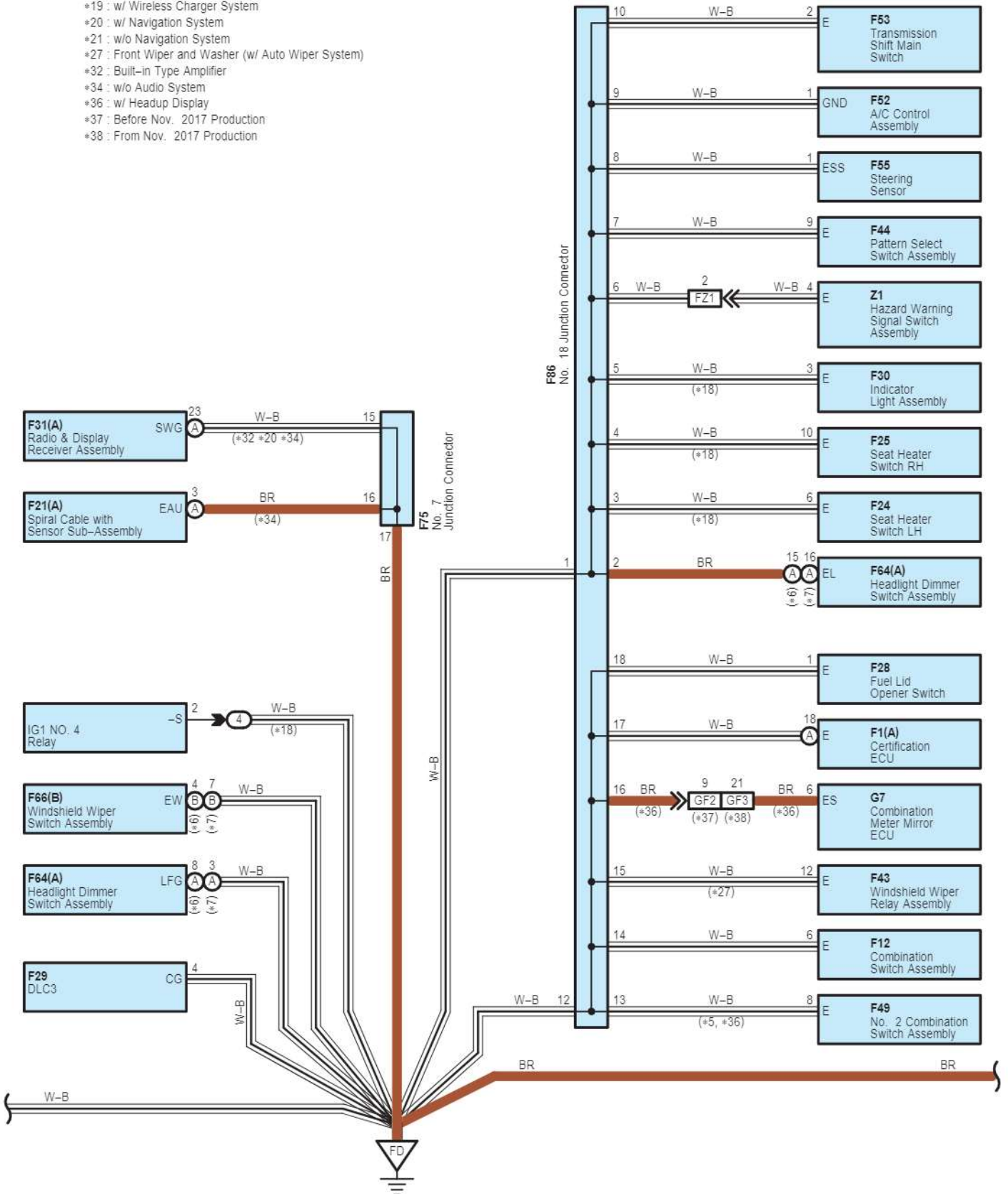



A18  
Gray

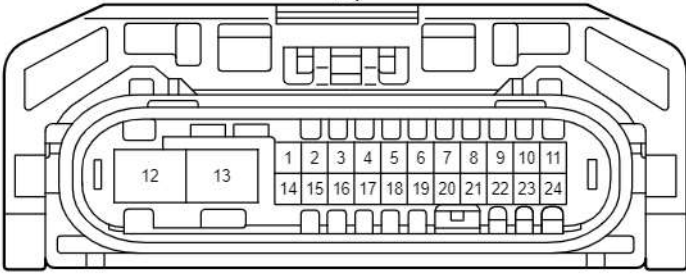

90980-12A92

A19  
Gray

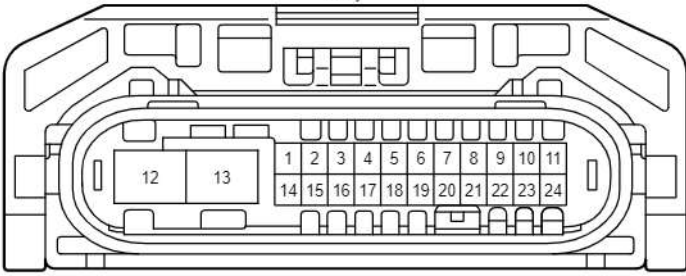

90980-12A92

A52  
Black

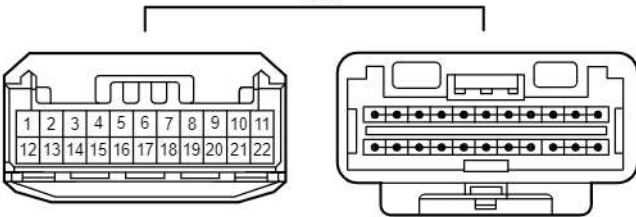

90980-12B54

A55  
Black

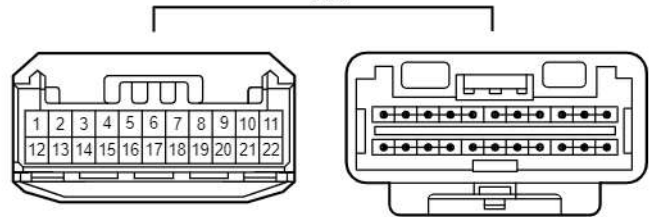

90980-12B54

A56  
Black

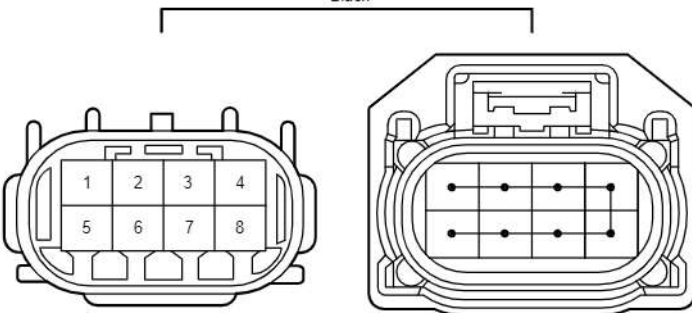

90980-12B56

# Lane Departure Alert

- \* 9 : w/ Headup Display
- \*14 : Before Nov. 2017 Production
- \*15 : From Nov. 2017 Production

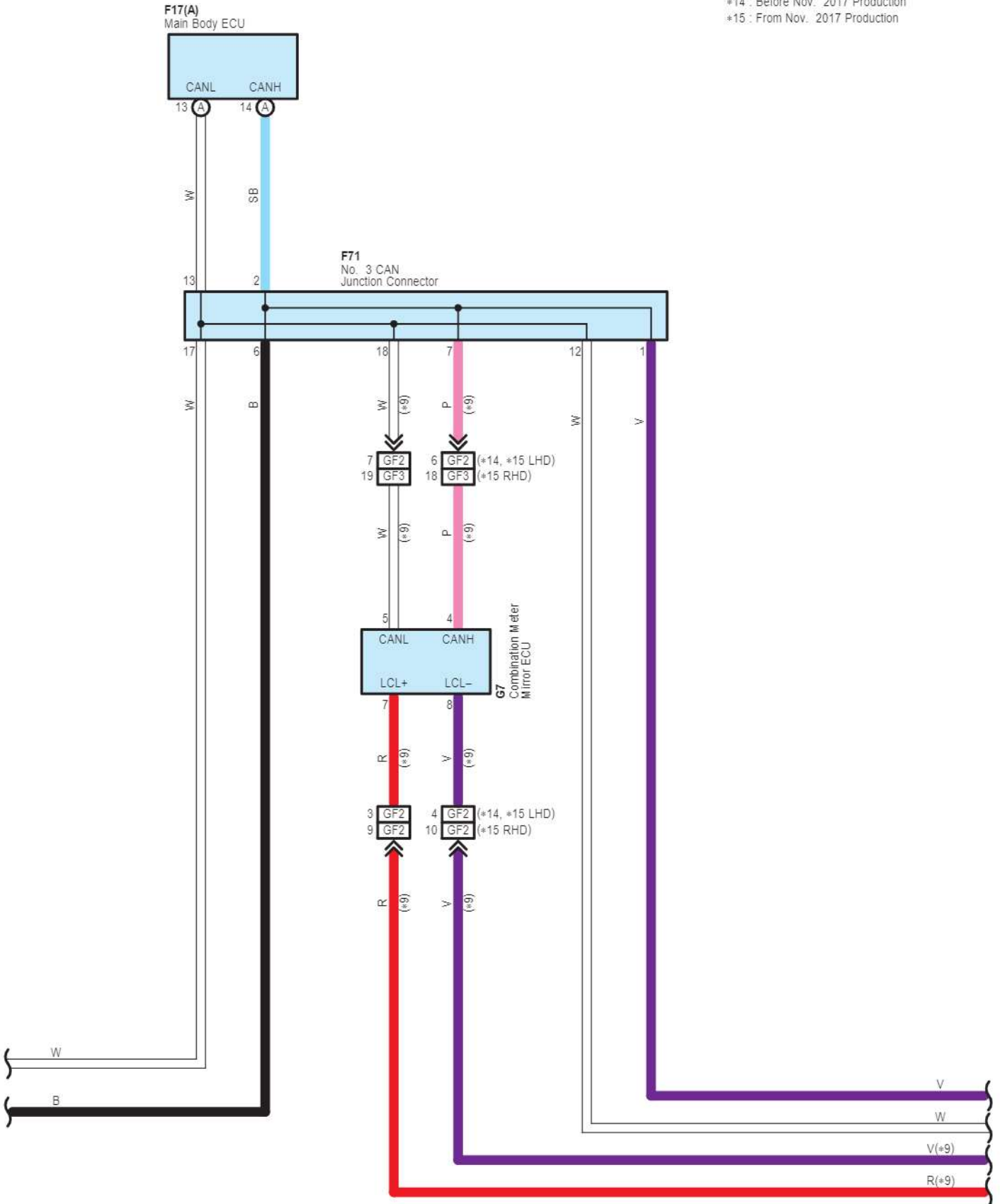

Power Outlet

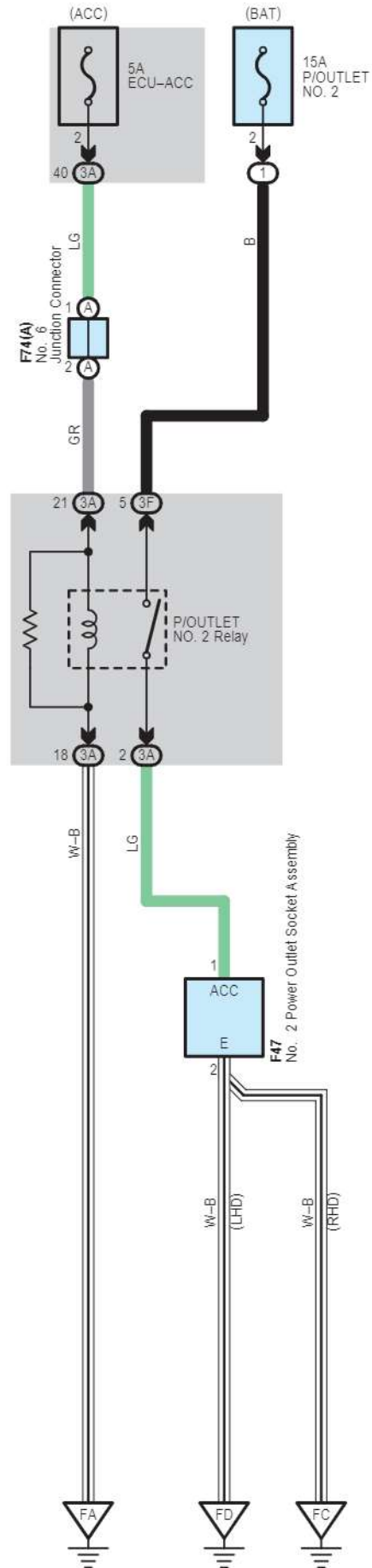
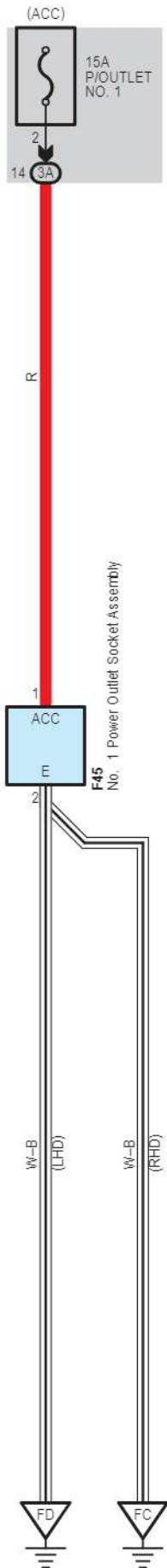

Seat Belt Warning

